

KUHL[®]
— MESSER —

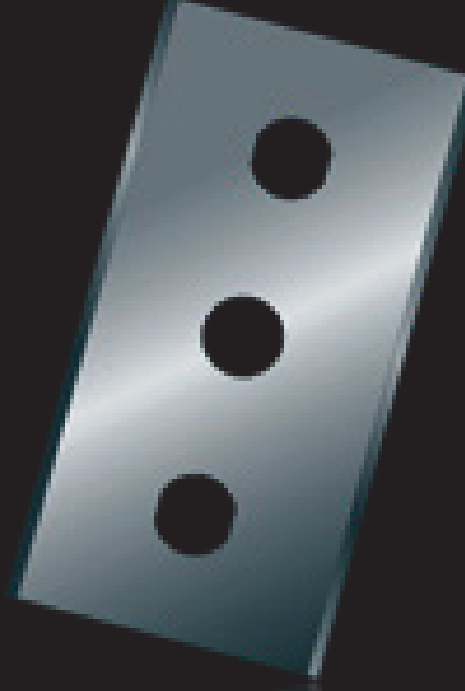

INDUSTRIAL BLADES
SANAYİ JİLETLERİ

Kuhl Messer



www.kuhlmesser.com

INDUSTRIAL BLADES
SANAYİ JİLETLERİ

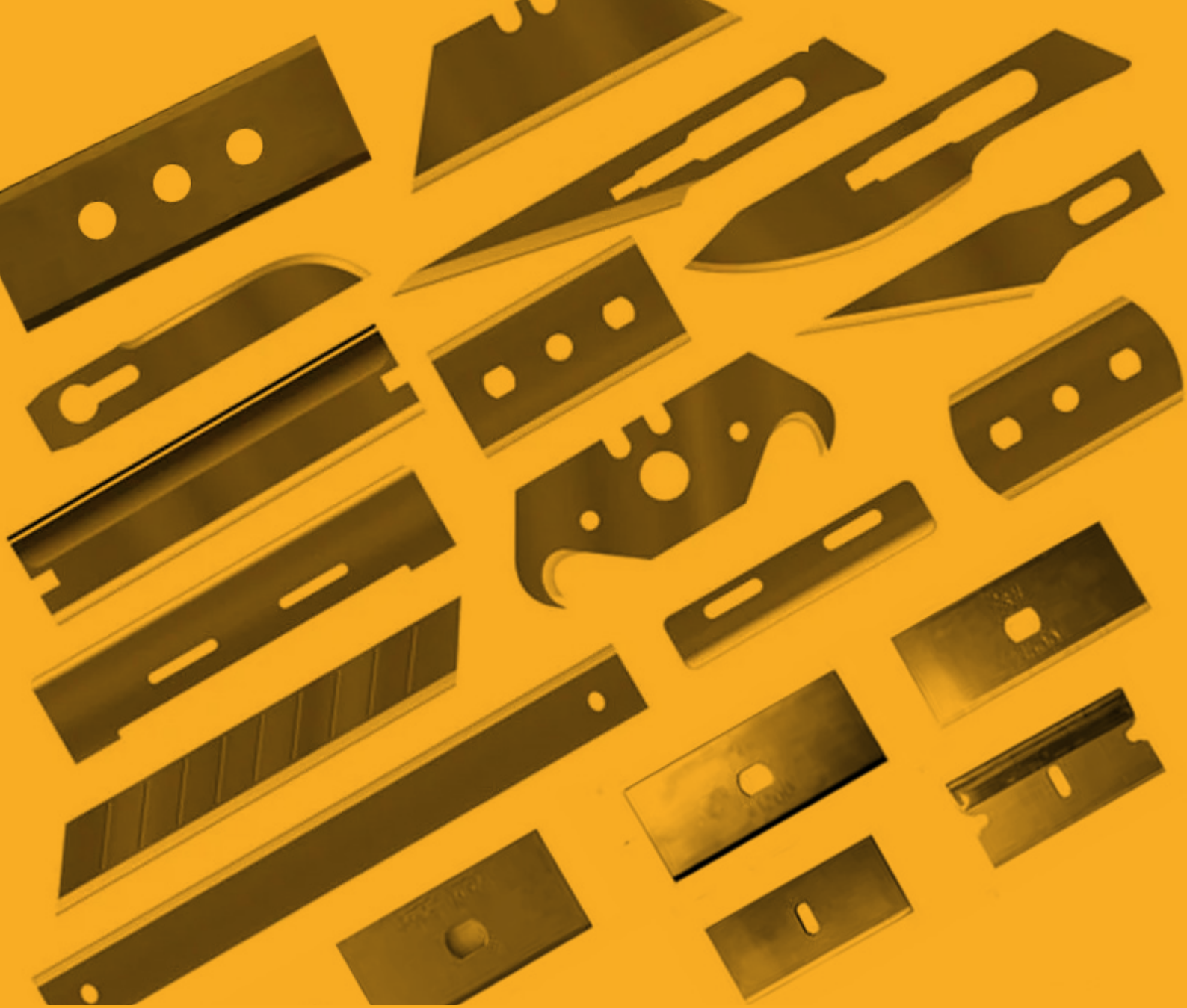

www.kuhlmesser.com

Katalogda yer alan ürün çeşitlerimizin haricinde farklı materyal, kaplama ve ölçüler mevcut olup, müşterilerimizin taleplerine göre stoklarımızdan temin edilmektedir.

Please be informed that besides our products mentioned here alternative materials, coatings and measurements are available from our company stock.

Dilme Jiletleri

Slitter Blades



3 Delikli Jiletler / 3 Hole Blades

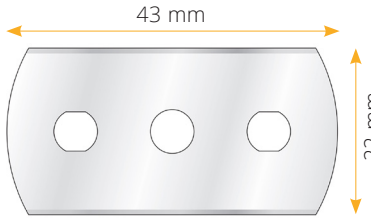

43 x 22 x Kalınlık / Thickness

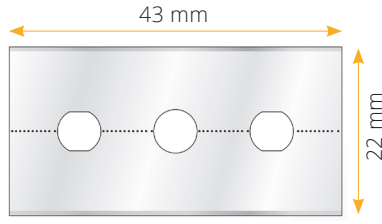

43 x 22 x Kalınlık / Thickness

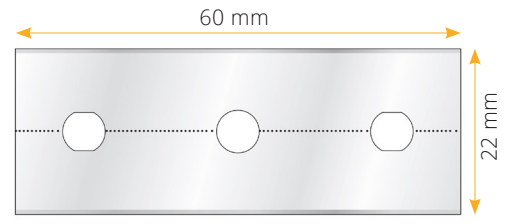

60 x 22 x Kalınlık / Thickness

Slotlu Jiletler / Slotted Blades

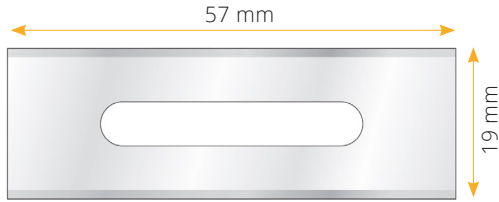

50 x 19 x 0.38 mm

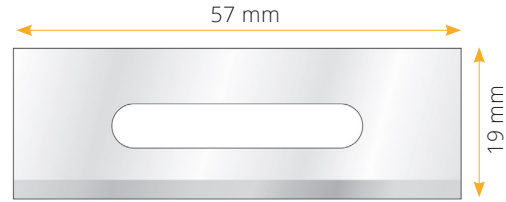

50 x 19 x 0.38 mm

Tek Kenarlı Jiletler

Single Edge Blades

Kıllı / With Spine

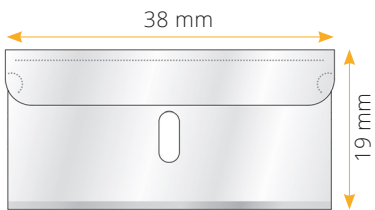

38 x 19 x Thickness*

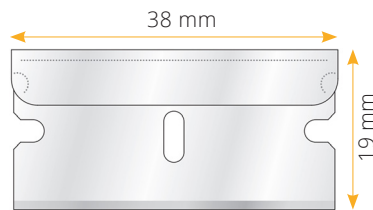

38 x 19 x Thickness*

Kıllsız / Without Spine



38 x 19 x Thickness*

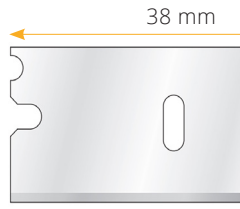

38 x 19 x Thickness*

İnjektör Jilet

Injector Blade

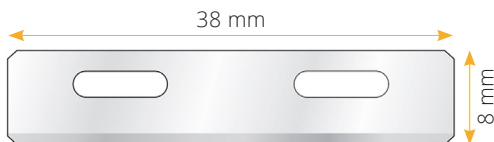

50 x 19 x 0.38 mm

Kanca Jiletler

Hook Blades

KUHL
MESSER

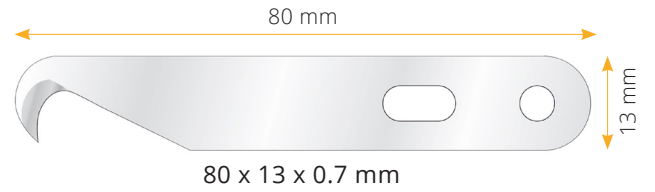
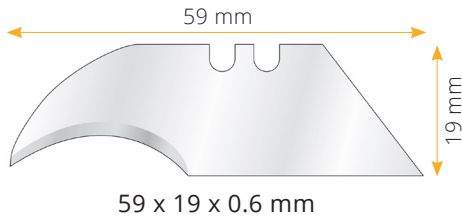
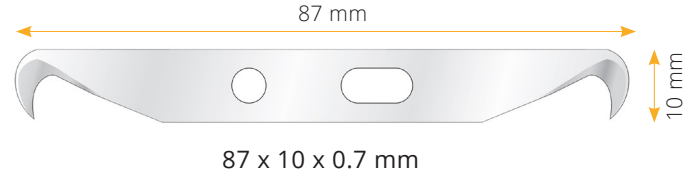
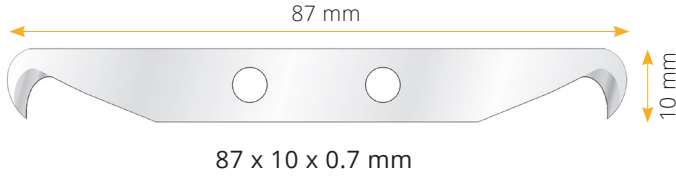
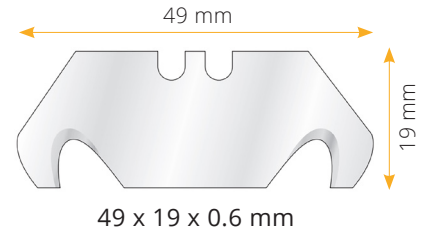
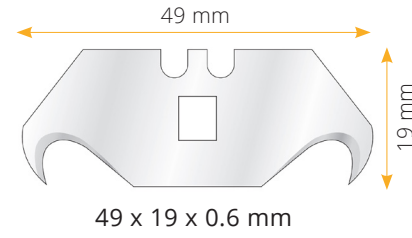
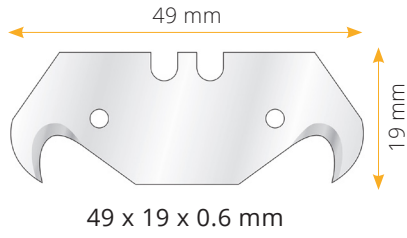
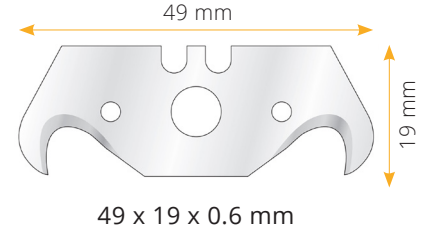
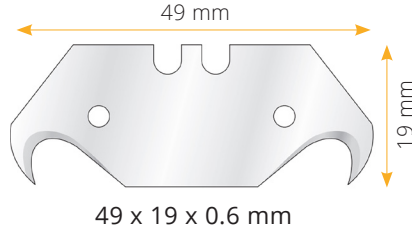
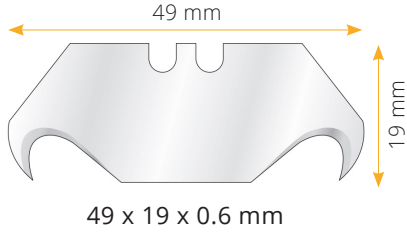

İnce Jiletler

Slim Knife Blades

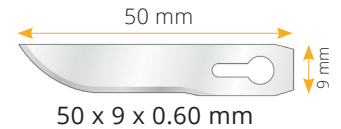
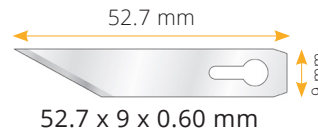
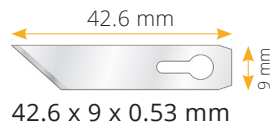
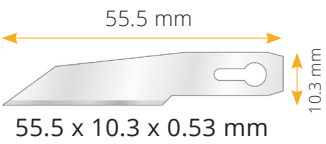

Lamel Yaprak Jiletler

Lamel Blades

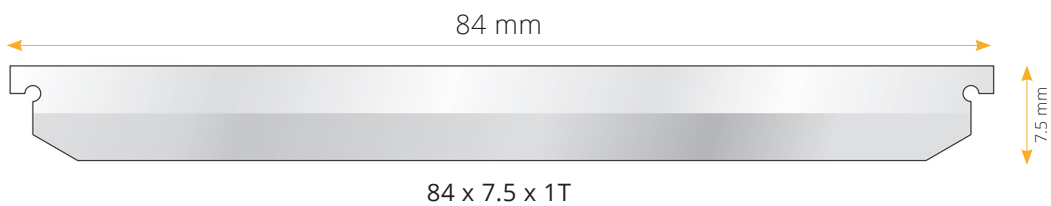

Elyaf ve Camelyafı Kesim Jiletleri

Fiber and Fiberglass Chopper Blades



74.4 x 16.6 x 0.884 mm

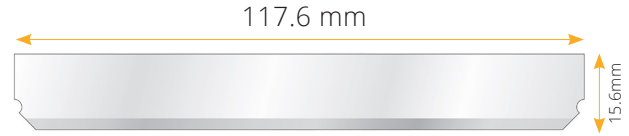

117.6 x 15.6 x 0.884 mm

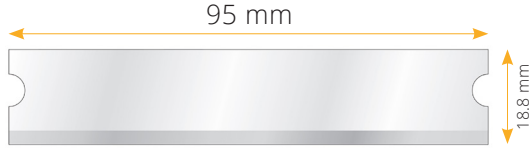

95 x 18.8 x 0.91 mm

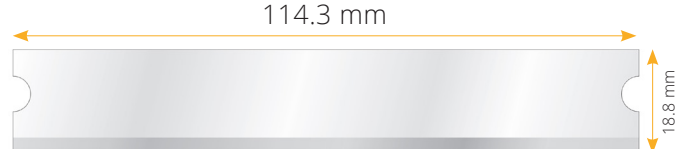

114.3 x 18.8 x 0.91 mm



Length x 7.94 x 0.71 mm

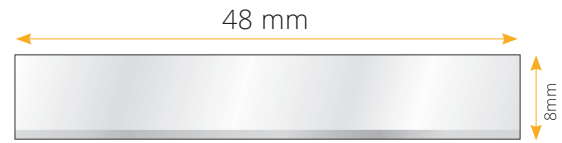

48 x 8 x 0.90 mm

Hobi Jiletler

Hobby Knife Blades

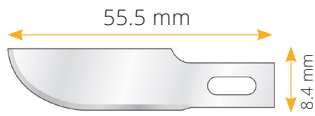

36.8 x 8.4 x 0.53 mm



40 x 9 x 0.53 mm

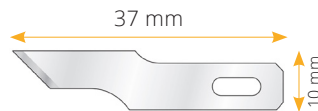

37 x 10 x 0.53 mm

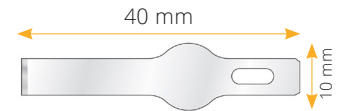

40 x 10 x 0.53 mm



45 x 13 x 0.63 mm
45 x 16 x 0.63 mm
45 x 20 x 0.63 mm



39 x 11.7 x 0.63 mm



45 x 10 x 0.60 mm

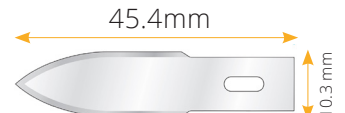

45.4 x 10.3 x 0.60 mm



39.4 x 11 x 0.63 mm



47 x 11 x 0.63 mm

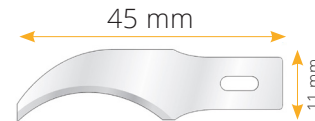

45 x 11 x 0.63 mm

Trapez Jiletler

Trapezoid Blades



Orta Zorluk Jiletleri / Medium Duty Blades (0.43 mm)

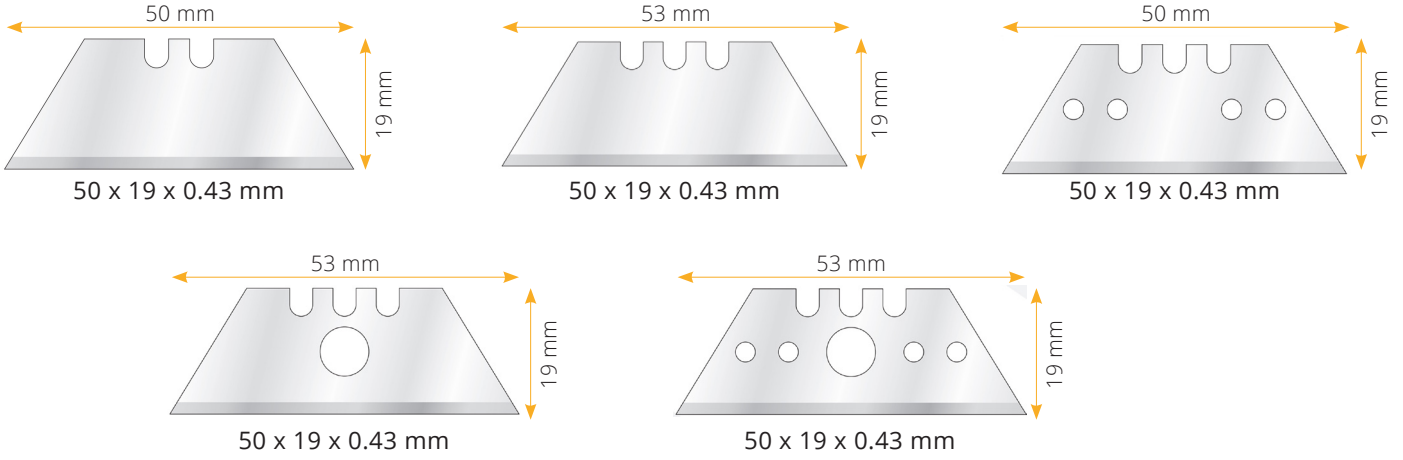

Yüksek Zorluk Jiletleri / Heavy Duty Blades (0.64 mm)

Kısa Tip / Short Type

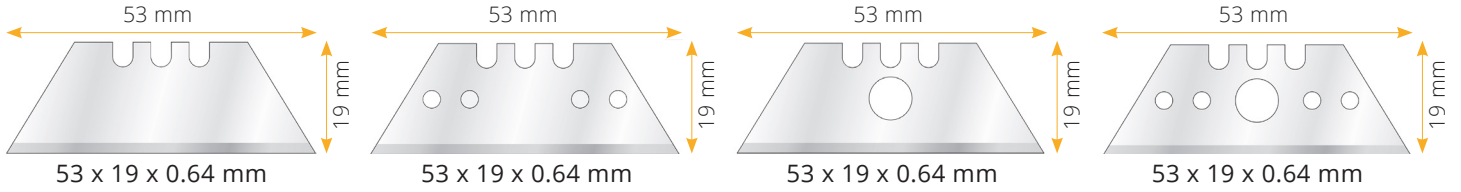

Standart Tip / Standard Type

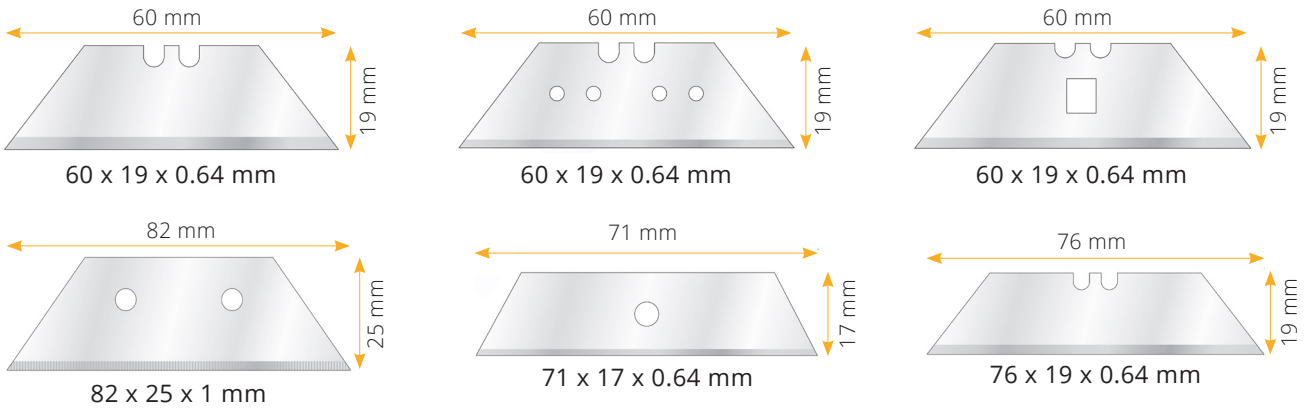

Duvar Kazıma Jiletleri

Wall Scraper Blades

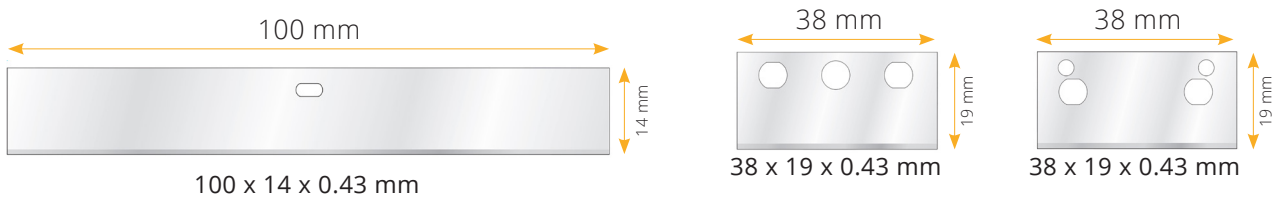

Falçata Jiletler

Snap Off Blades

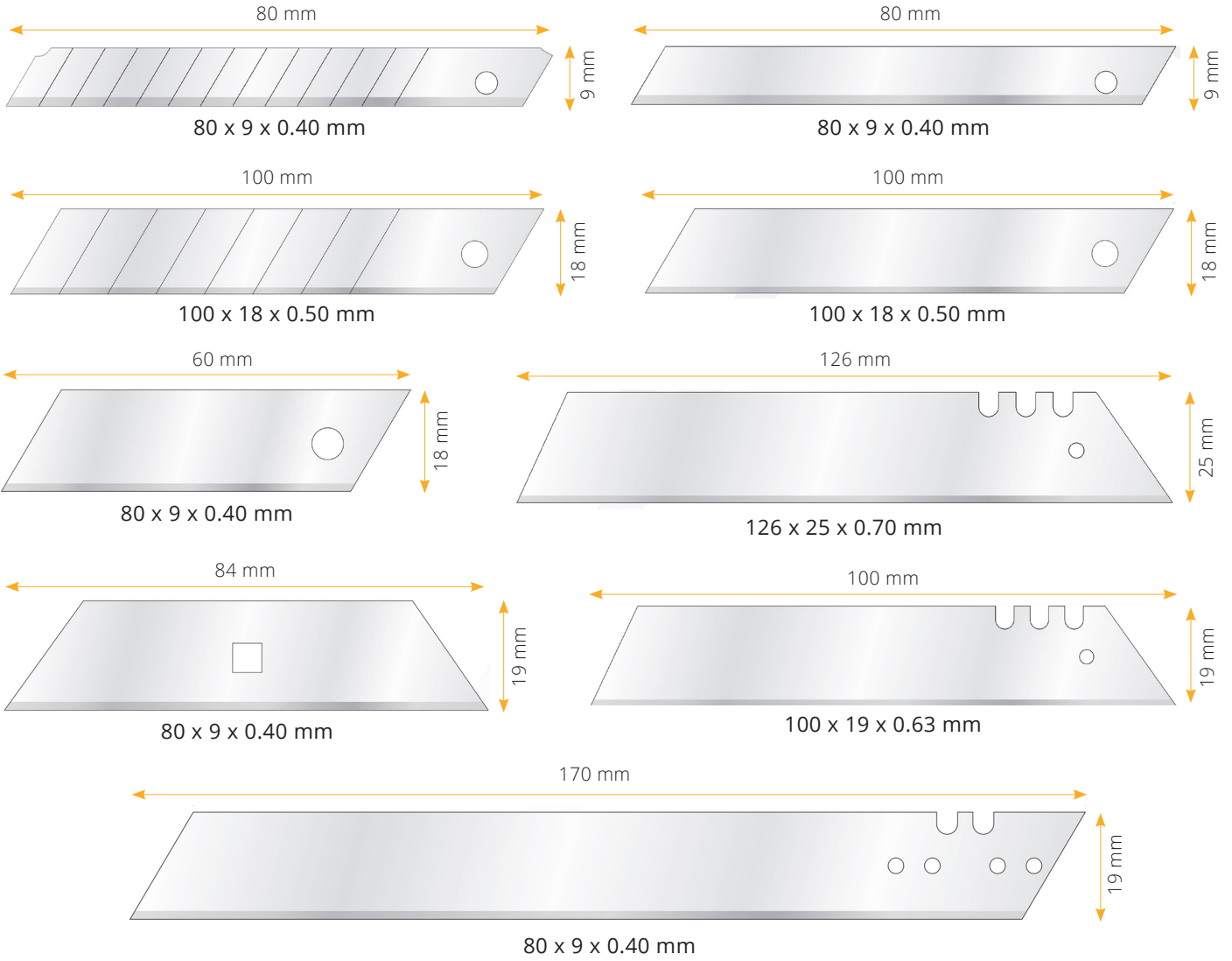

Beşgen Jiletler

Pentagon Blades

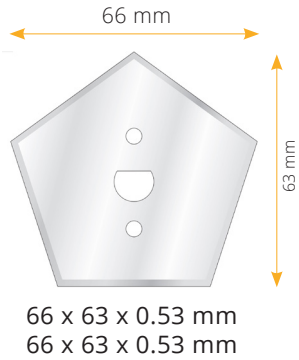

Dairesel Jiletler

Circular Blades

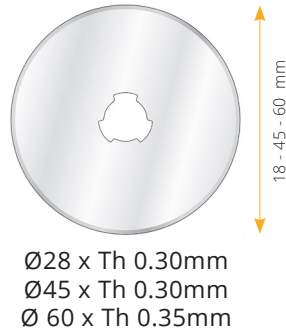



KUHL®

MESSER

INDUSTRIAL BLADES
SANAYİ JİLETLERİ

Kuhl Messer



www.kuhlmesser.com

Kühl Messer TÜRKİYE
İncilipınar Mah. Muammer Aksoy Blv Sever İş Mrk.
Kat. 4 No: 403 Şehitkamil / GAZİANTEP

İLETİŞİM
+90 545 227 15 15
info@kuhlmesser.com